

***Hella Rotating Beacon and Siren***

***System RTK 6-SL (12/24 V)***

***Technical Manual***



**STOP**



***Ideas today for  
the cars of tomorrow***

# **Hella Rotating Beacon and Siren System RTK 6-SL (12/24 V) 2RM 007 200-...**

**Workshop Manual**  
Installation and  
Operating Instructions

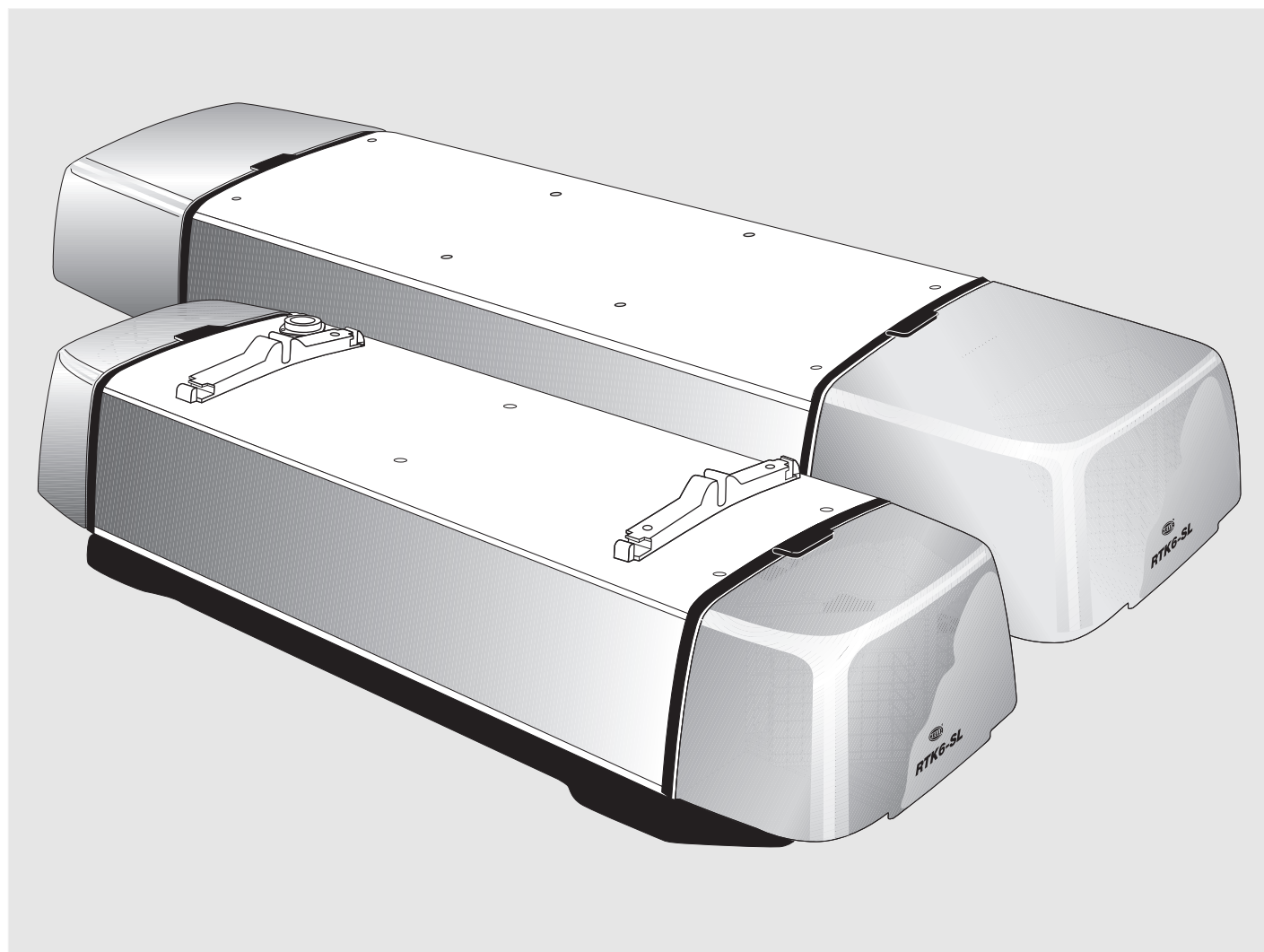

# **Workshop manual**

## **Rotating beacon and siren system RTK 6-SL (12/24 V)**

**2RM 007 200-...**

<b>Contents 1</b>		Page
<b>1.0</b>	<b>General information</b>	<b>4</b>
<b>2.0</b>	<b>Operation</b>	<b>5</b>
2.1	Device discription	5
2.2	Operating instructions	7
2.3	Control unit for use with US tonal sequence	8
<b>3.0</b>	<b>General technical data</b>	<b>10</b>

## 1.0 General information

The Hella RTK 6-SL device is a new development of a modular design.

A microprocessor-controlled central control unit and an electronic bus system help to considerably reduce the amount of cabling and to facilitate installation. Increased requirements concerning electromagnetic compatibility are fully complied with.

The Hella RTK 6-SL system is completed by an „intelligent“ control unit. System failures and faults are recognised and indicated optically and acoustically.

The central control unit has a clear and user-friendly layout. The possibility of operating faults has been reduced to a minimum by the ergonomic control panel and its display.

Hella RTK 6-SL is a sophisticated system for your emergency vehicles. Its modular design offers you a number of options ranging from the basic variant to its maximum configuration. Your advantage: whenever you find that additional functions are practical that's not a problem, because you can retrofit the system with all function modules.

The RTK 6-SL is based on German technical directives for radio patrol cars (TR Funkstreifenwagen) and on the current as well as the increased EMC conditions in accordance with TR 010 and BOS Directives.

The acoustic and optical warning devices correspond to the requirements of StVZO, ECE, ISO 7640, DIN 14610/14621/14630.

The requirements of national and international type approvals have been complied with.

## 2.0 Operation

### 2.1 Device description

The control unit consists of a control device and a control panel.

The ergonomically styled control panel is divided into three sections.

The keys are backlit and give a tactile response when pressed, avoiding operational faults.

The LC display with its large reading angle provides clear information about all active functions.

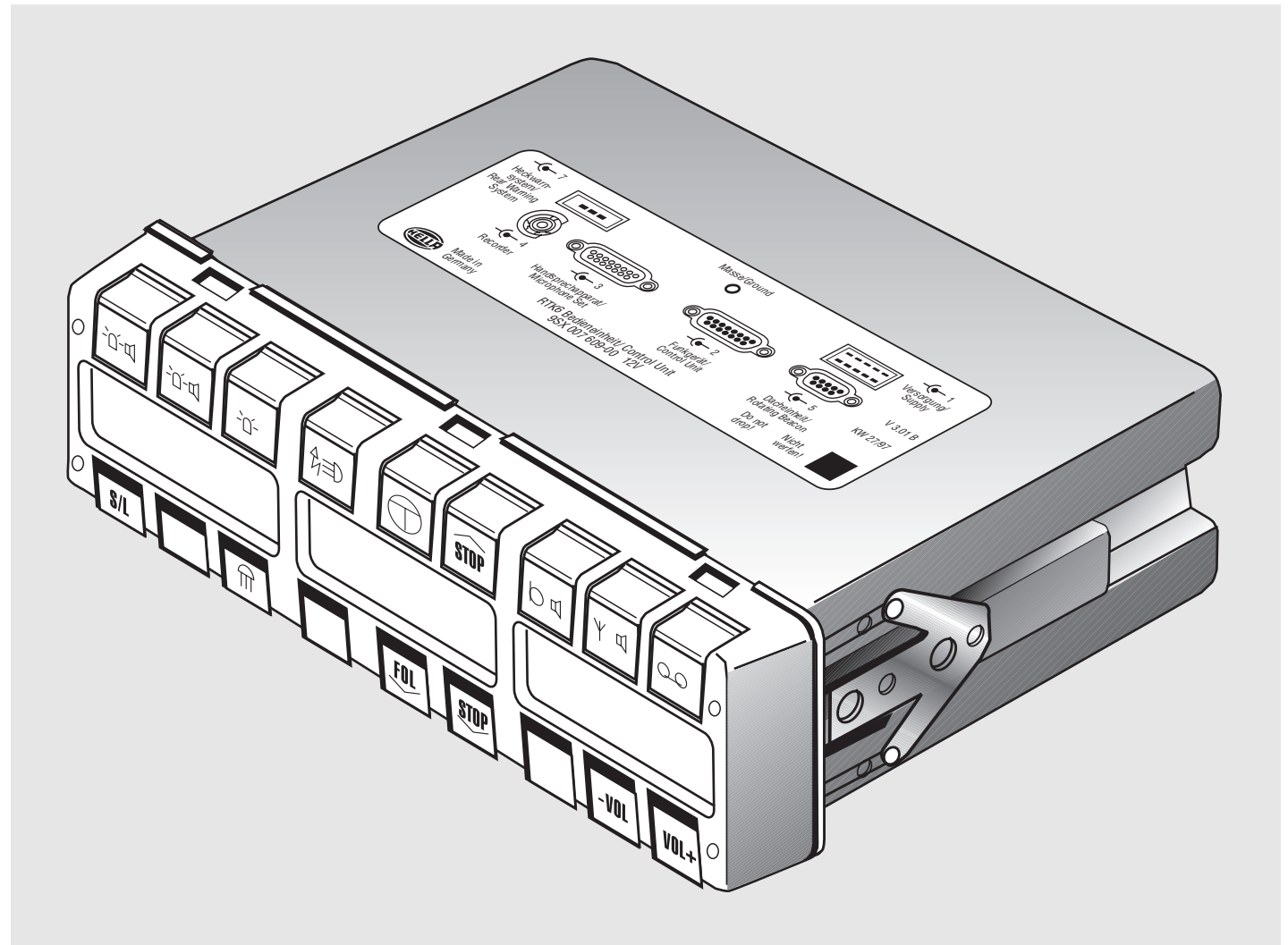

**Compact control unit for mounting in the radio slot according to DIN/ISO 7736.**

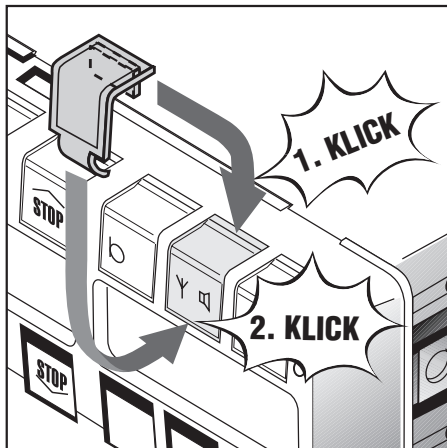

Keys that have no function due to the roof configuration are „clipped“ (with black or transparent clips) after coding to block them mechanically.

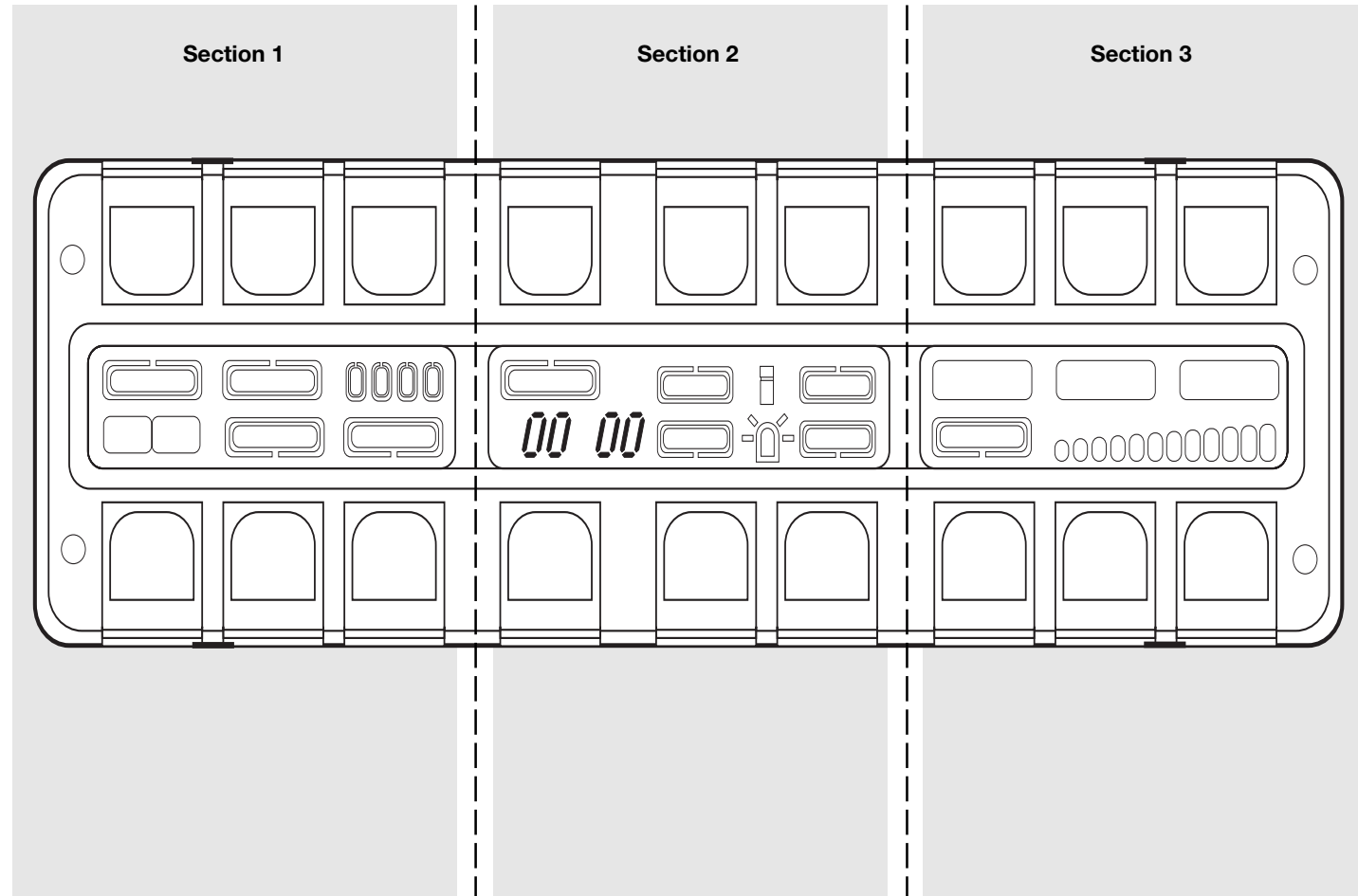

**Section 1**  
to control the acoustic and optical part of the special signal of the RTK 6-SL including control and warning functions via LC display or acoustic indication (gong).

**Section 2**  
to control the optical STOP signal generator, the flashing headlamp, the additional beacon plus control functions of the information signs or plugged-in additional rotating beacon if applicable.







**Section 3**  
to control the radio functions (transmission of speech and radio messages) including volume adjustment, and control of externally connected tape recorder, CD player or similar.







# Operation

## 2.2 Operating instructions

- Depending on the labelling of the control panel, a particular key may be assigned different functions (modules), see sections 4.4 - 4.7.
- Some key have dual functions (switching on and off of one module).
- Some of the keys are interlocked
- Each key is assigned a function indicator; some of the indicators are also used as fault or malfunction indicators (flashing border).
- Keys without function (e.g. no ASG connected) sound different „gong“ signals as indication.
- An additional feature is the control of the rear warning lamps (HWL).

## LC display messages

Symbol	Function
	The corresponding function is active and OK
	The corresponding function is active and not OK
	The corresponding function is not active and not OK (defect memory)
	Beacons or flashing headlamps are on (max. 4 lights)
	Urban/rural signal indicator
	Volume level indicator (speech transmission, radio, tape recorder etc....)

Symbol	Function
	INFO sign is mounted, flashing symbol. Gong sounds every 10 s while ignition is on
	KL-A has been plugged in and is active (OK). Gong sounds every 10 s while ignition is on
	KL-A has been plugged in and is defective (not OK) (inside and outside flash alternately). Gong sounds every 10 s while ignition is on.
	KL-A has not been plugged in and is not active (not OK) (defect memory)
	= static
	= flashing

# Operation





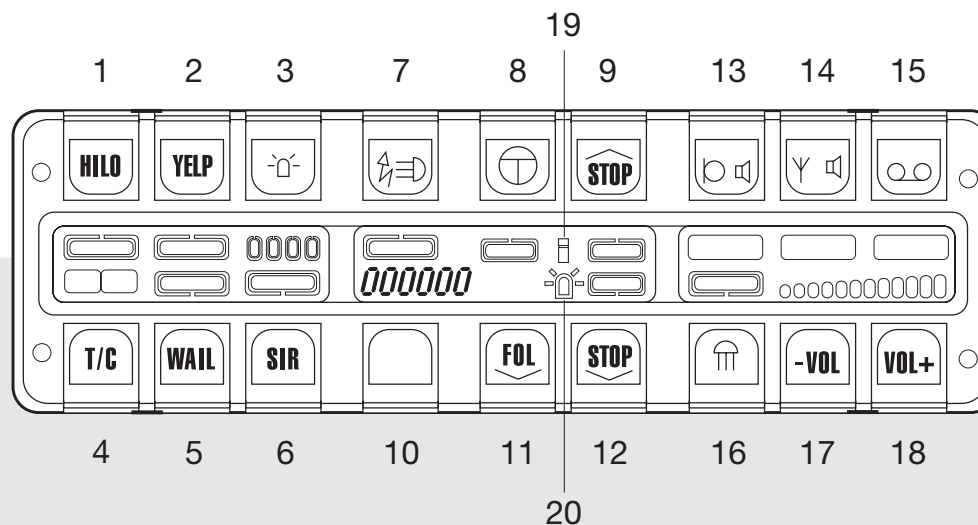

## 2.3 Control unit for use with US tonal sequence

Part no. 9SX 007 609-041



No.	Symbol	Function / Comment
1	<b>HILO</b>	<b>Permanent run of special signal (HI-LO)</b> , optical and acoustic signals are on, interlock with keys 2, 5 and 6.
2	<b>YELP</b>	<b>Permanent run of special signal (YELP)</b> , optical and acoustic signals are on, interlock with keys 1, 5 and 6.
3		<b>Beacons</b> (max. 4) are on. <b>Note:</b> keys 1 - 3, 5 and 6 are interlocked.
7		<b>Flashing headlamp</b> (BSX) only works if beacons are on
8		<b>Flasher lamps:</b> in Switzerland this function is only available if all special signal functions (keys 1 - 3, 5 and 6) are switched off except with coded continuous function.
9		Front STOP signal generator (ASG) <b>STOP POLICE</b> signal laterally inverted.
13		<b>Microphone announcement</b> via RTK 6-SL loudspeaker using hand-held microphone. If a separate microphone is used the function is started by pressing the speaking key.



14		<b>Incoming radio transmission</b> (headquarters) can be directed to the RTK 6-SL loudspeakers.
15		<b>Radio/recorder</b> information can be directed to RTK 6-SL loudspeakers. <b>Note:</b> keys 13 to 15 are interlocked. Depending on the coding the keys 1, 2, 5 and 6 have priority above key no. 13.
4	<b>T/C</b>	<b>Switchover function between urban and rural area</b> for tonal sequence and audio loudspeaker transmission. Keys 1, 2, 5 and 6 always have priority for keys 14 and 15.
5	<b>WAIL</b>	<b>Automatic siren.</b> Interlocked with keys 1, 2 and 6.
6	<b>SIR</b>	<b>Manual siren.</b> interlocked with keys 1, 2 and 5. Holding key = siren runs ups Releasing key = siren runs down
10		Not used
11		Rear STOP signal generator (ASG): <b>FOLLOW ME</b> signal
12		Rear STOP signal generator (ASG): <b>STOP POLICE</b>
16		<b>Front flashing or rear warning lamps</b> (HWL) without key function; is automatically activated if the beacons are on when you open the boot lid. Depending on the coding the key functions can be used / not used
17	<b>-VOL</b>	<b>Volume adjustment</b> for the keys 13 ... 15; has no function for key no. 13
18	<b>VOL+</b>	if microphones with integrated <b>volume adjustment</b> are used.
19		No key: (flashing) display message for information e.g. TRAFFIC JAM sign
20		No key; beacon - plug-in (KL-A) flashing display message
	Option	<b>External key</b> for special YELP signal activation for 10 seconds (tonal sequence and beacons). Interlocked with keys nos. 1, 5 and 6.

## 3.0 General technical data

- **RTK 6-SL:**  
is based on the German technical directive for radio patrol cars (TR Funkstreifen wagen)
- **Optics and acoustics:**  
in accordance with the requirements of StVZO, ECE, ISO 7640, DIN 14610/14621/14630
- **EMC regulations:**  
VDE 0879 Part 3; 5th degree of interference suppression according to technical directive for radio patrol cars in accordance with TR 010 and BOS directives  
DIN 40839 Parts 1 to 3 DIN/VDE 57879 Part 3 ISO 7673 Parts 1 and 2 CIPSP 25
- **Type test approval marks:**  
StVZO  
 ~~~~ K 18668 (KL-DC)  
 ~~~~ K 18669 (KL-XR)  
 ~~~~ K 18670 (BS-X)  
 ~~~~ M 25024 (LSP)  
 ECE  
 B1 (E1) 00433 (KL-DC)  
 B1 (E1) 00434 (KL-XR)  
  
 EWG  
 [e1] 020995 (EMV)

### Interface between control unit / roof construction

|   |             |
|---|-------------|
| Bi-directional single-wire control bus: | UART        |
| Unidirectional audio frequency bus:     | 5 V/100 kHz |

### Module configuration (U<sub>N</sub>)

|                                    | 12 V    | 24 V    |
|------------------------------------|---------|---------|
| Rotating beacon (2 per system):    | ~ 5.0 A | ~ 3.0 A |
| Flashing beacon (2 per system):    | ~ 4.5 A | ~ 2.2 A |
| LED STOP signal:                   | ~ 1.0 A | -       |
| Bulb STOP signal:                  | ~ 3.6 A | -       |
| Flashing headlamp:                 | ~ 1.5 A | -       |
| Plug-in type beacon:               | ~ 4.5 A | -       |
| Flasher lamps - yellow (2 x 21 W): | ~ 3.6 A | -       |

(The figures represent the average current consumption of one module unit. The overall current consumption can be calculated by adding up the current values depending on the RTK 6-SL module configuration).

|                      |         |         |
|----------------------|---------|---------|
| <b>Control unit:</b> | ~ 0.5 A | ~ 0.5 A |
|----------------------|---------|---------|

### General information:

|   |  |
|---|--|
| Degree of protection (roof construction): | IP 5K 4K or IP X 9K resp. (high-pressure cleaners), DIN 40050, Sheet 9 |
| Operating temperature:                    | -40°C... +60°C   |
| Storage temperature:                      | -40°C... +85°C   |

### Dimensions:

|                                 |                  |
|---------------------------------|------------------|
| Length:                         | 1100 mm/ 1400 mm |
| Width:                          | 350 mm           |
| Height (without rubber frame)   | 189 mm           |
| Weight (min. version)           | 15.4 kg          |
| Weight (max. version)           | 22 kg            |
| Shore hardness of rubber frame: | 50 Shore         |

|   |              |               |
|---|--------------|---------------|
| <b>Nominal voltage (U<sub>N</sub>):</b> | 12 V         | 24 V          |
| Operating voltage (U <sub>B</sub> )     | 9.0 - 16.0 V | 18.0 - 30.0 V |
| Undervoltage (display: — Volt)          | < 10.0 V     | < 20.0 V      |
| Overvoltage (display Volt ++)           | > 16.0 V     | > 32.0 V      |
| Quiescent current consumption:          | 12 V ≤ 1 mA  | 24 V ≤ 1 mA   |

**Special acoustic signal (DIN 14610):**

|                                |  |         |
|--------------------------------|--|---------|
| Power amplifier: 105 W         |  |         |
| Loudspeaker 70 W; 8 Ω (front): | ~ 5.5 A                                      | ~ 3.0 A |
| Loudspeaker 35 W; 16 Ω (rear): | ~ 2.5 A                                      | ~ 1.5 A |
| Sound intensity level:         | in accordance with DIN 14610 and StVZO § 22a |         |

**Potential allocation of external connectors:**

|                     |                     |                              |
|---------------------|---------------------|------------------------------|
| Recorder/CD player: | max. 2 V eff.       |                              |
| UDS-tachograph      | A5 (tonal sequence) | + U <sub>B</sub> max. 400 mA |
|                     | B4 (beacon)         | + U <sub>B</sub> max. 400 mA |
| Output plug 7       | Pin 2               | + U <sub>B</sub> max. 300 mA |



*Ideas today for  
the cars of tomorrow*